

# Montaj Klavuzu

## Assembly Manual

Boss serisi Kare / Köşe Girişli Kabinler.  
Square / Corner Entrance Cabinets.

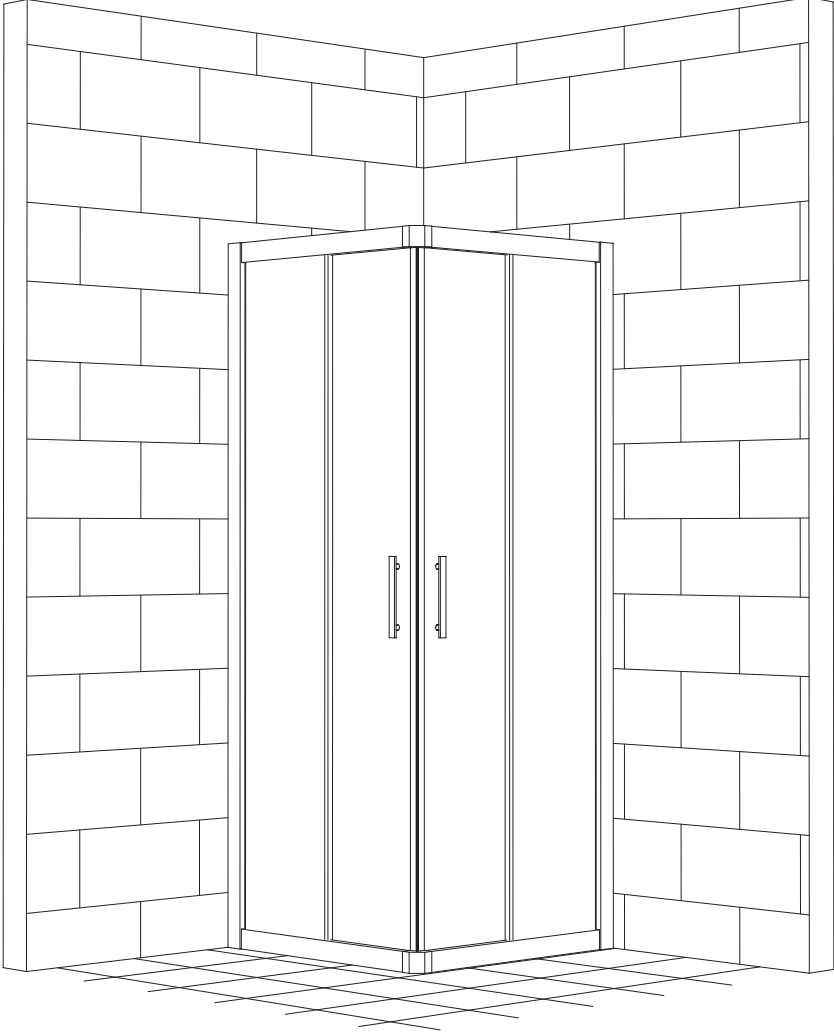

**Shower**<sup>®</sup>  
Banyonuzun incisi...

# 1

## DUVAR PROFİLLERİNİ TERAZİYE ALIP VİDA DELİKLERİNİ DUVARA İŞARETLEYİN.

VERTICAL PROFILE AND DETERMINE  
THE HOLES.

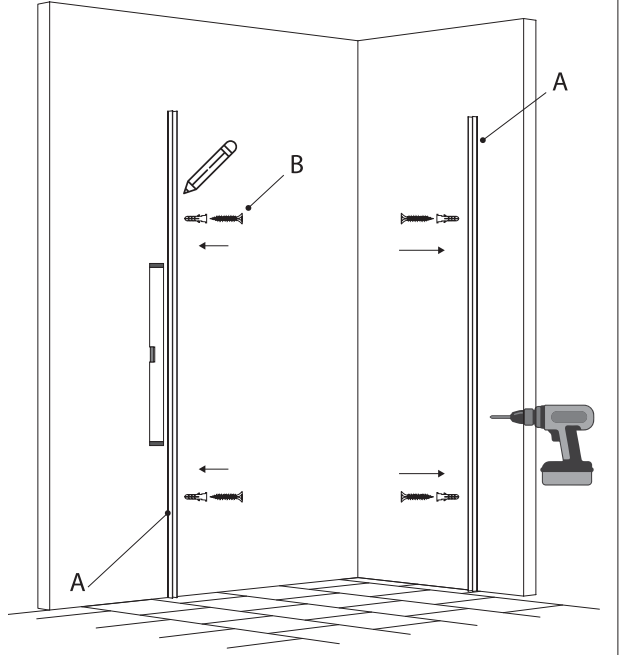
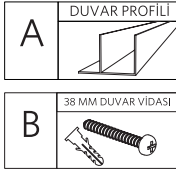

# 2

## RAYLARI KÖŞE TAKOZLARINA İÇTEN VIDALAYIN.

(Şekil 1 - Şekil 2)

SCREW THE RAILS INSIDE  
THE CORNER BLOCKS.

Şekil 2

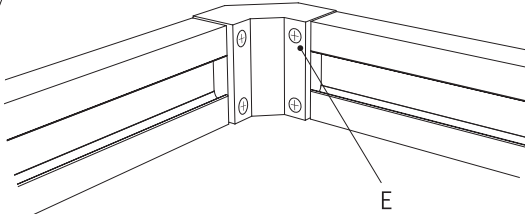

Şekil 1

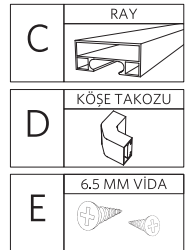
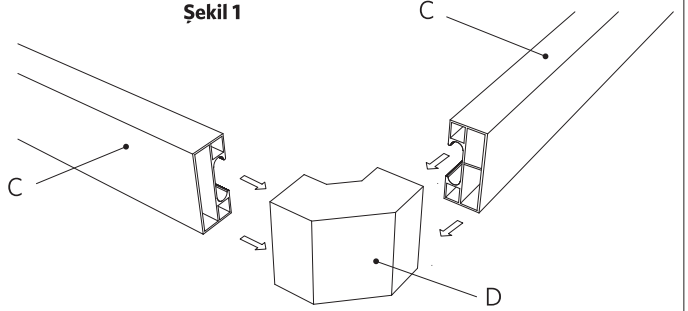

# 3

## ALT RAYLARI CAM PROFİLLERİNE VİDALAYIN (Şekil 3) VE KASAYI OLUŞTURUN.

SCREW RAILS TO GLASS PROFILES  
BOTTOM CREATE THE CASE.

Şekil 3

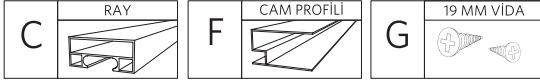
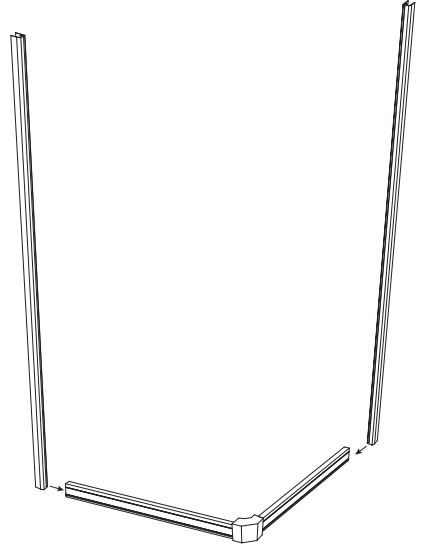
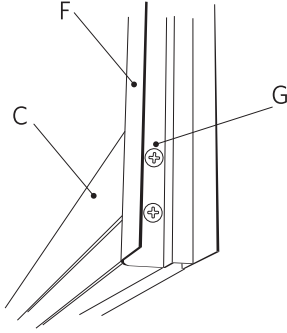

# 4

## SABİT CAMLARI YERİNE TAKIN.

REPLACE FIXED GLASS.

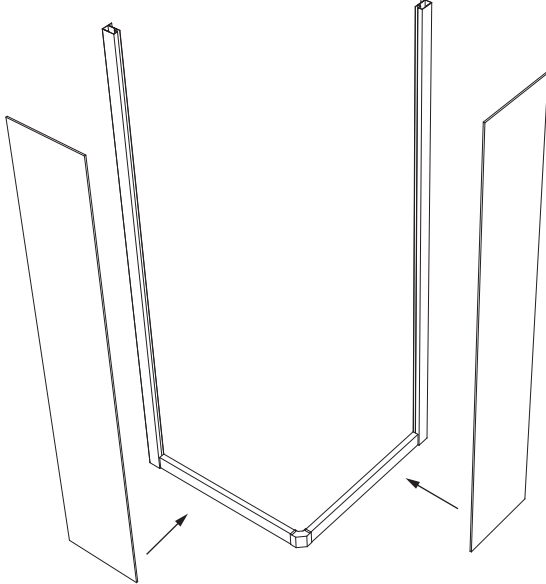

# 5

## ÜST RAYI TAKIN (Şekil 4) VE VİDALAYIN. (Şekil 5)

INSERT THE TOP RAIL AND  
SCREW.

Şekil 5

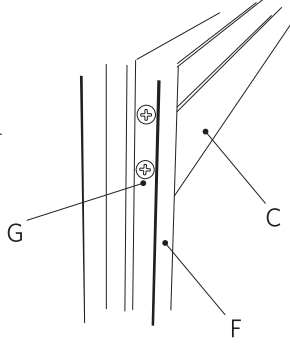

Şekil 4

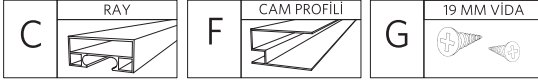
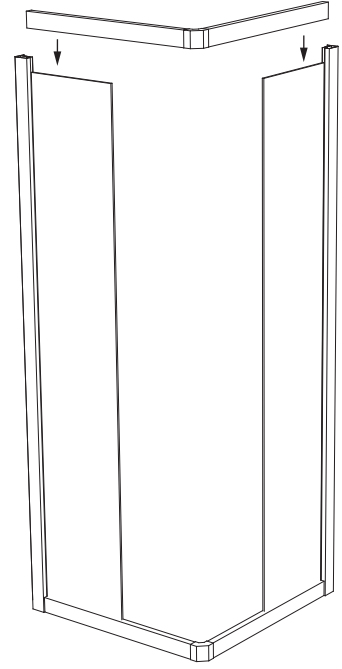

# 6

## OLUŞTURULAN KASAYI DUVAR PROFİLLERİNE SABİTLEYİN. (Şekil 6)

INSERT THE TOP RAIL AND  
SCREW.

Şekil 6

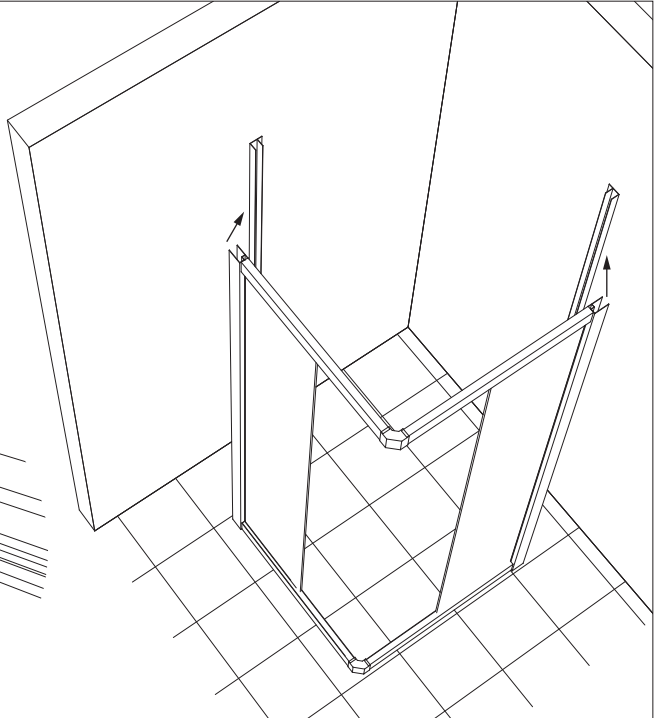
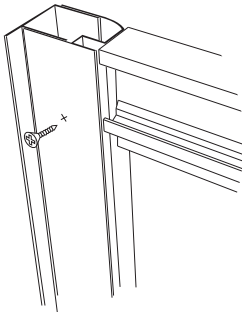

# 7

## HAREKETLİ CAMLARA TEKERLEKLERİ ve KULBU VİDALAYIN.

FIT THE WHEEL AND HANDLES.

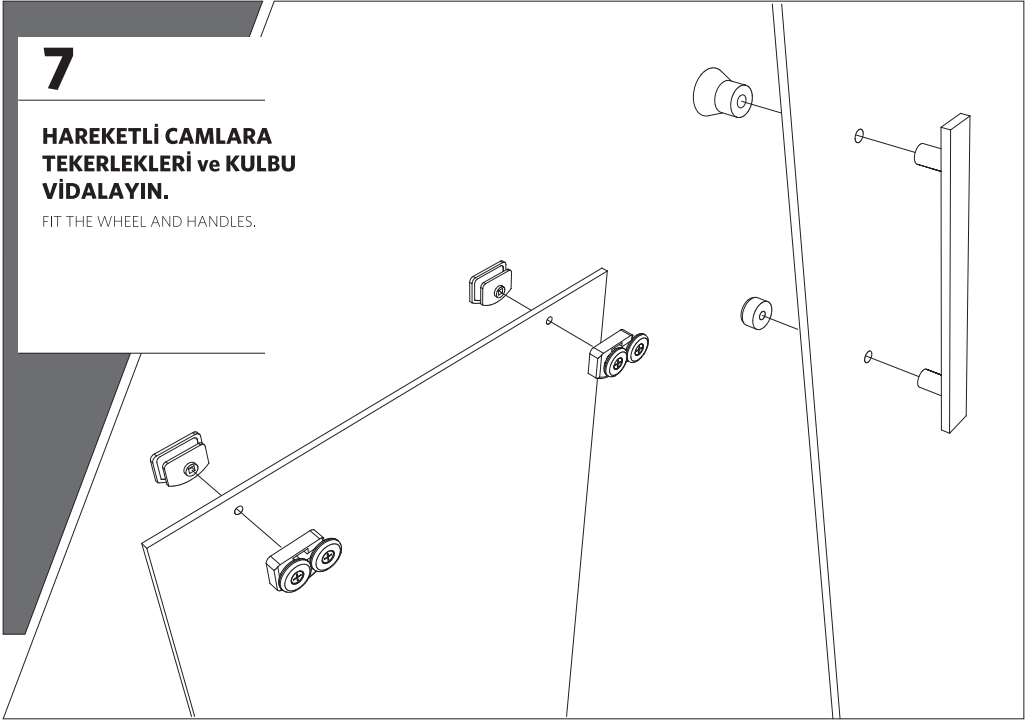

# 8

## HAREKETLİ CAMI YERİNE TAKIN, AYARLARINI YAPIN.

INSTALL THE GLASS, MAKE THE  
ADJUSTMENTS.

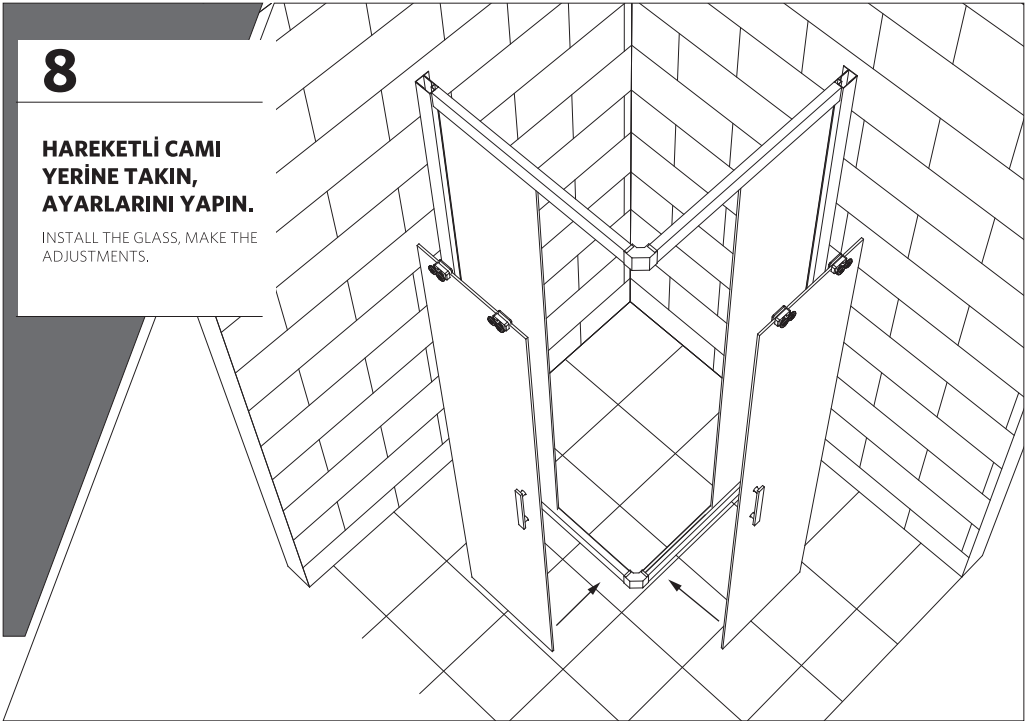

# 9

## KAPILARA MIKNATISLARI TAKIN.

PLACE MAGNETS ON THE DOOR.

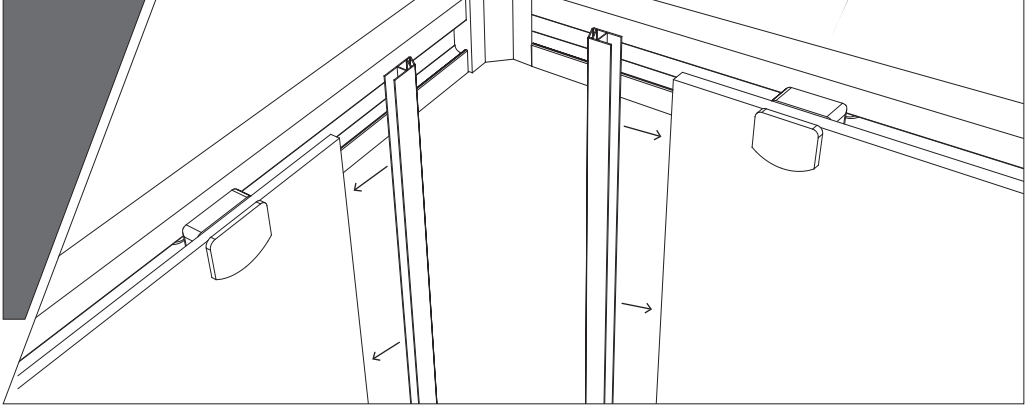
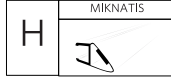

# 10

## SABİT CAMLARA SULUĞU TAKIN.

PLACE GASKET ON THE FIXED GLASS

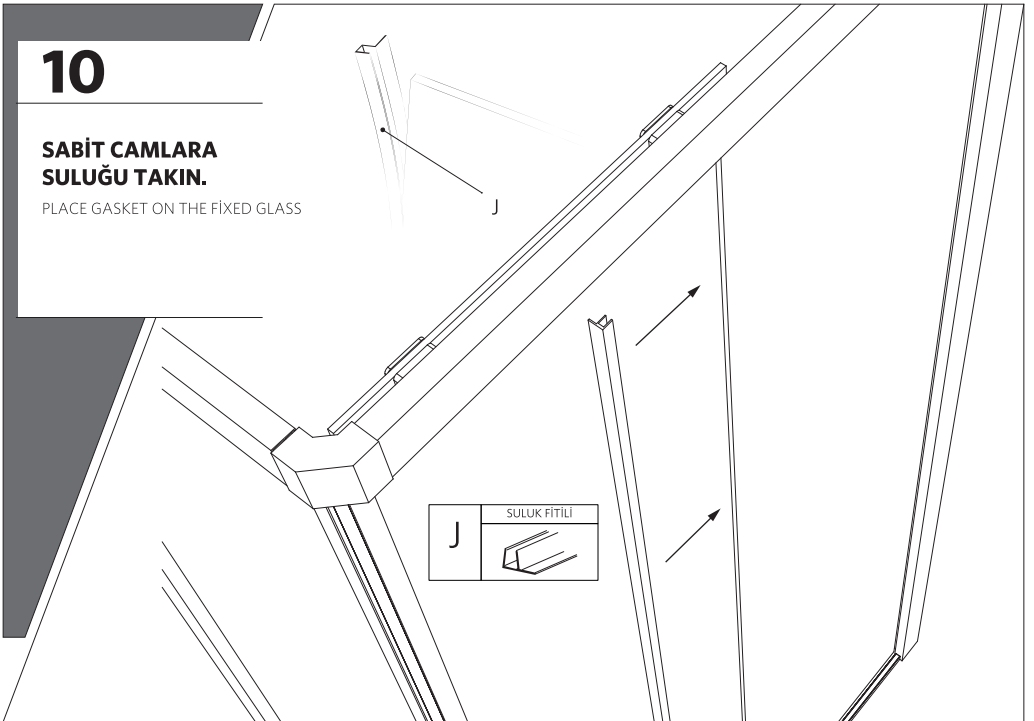
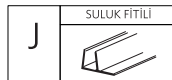
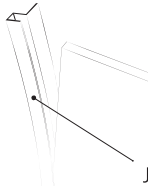

# 11

## STOPLERİ AYARLI ŞEKİLDE SABİTLEYİN

SET AND FIX ALL  
STOPERS.

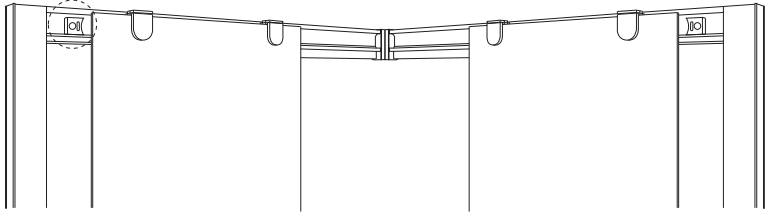
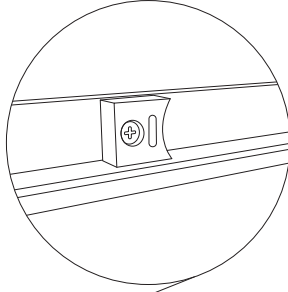

# 12

## ÜRÜNÜN TÜM KONTROLLERİNİ YAPIP GEREKLİ YERLERE SİLİKON UYGULAYIN.

DO ALL THE CONTROLS OF THE PRODUCT  
AND APPLY SILICONE TO NECESSARY SECTIONS.

